



# SACHS 50

REPAIR MANUAL

July 1956 Edition

FICHTEL & SACHS AG, SCHWEINFURT (MAIN)

# Table of contents

	Page
<b>Preface</b> .....	2
<b>Specifications</b> .....	3
<b>1. Repair Tools</b> .....	4
1.1 Standard tool set .....	4
1.2 Special service tools .....	5
1.3 F & S assembly compressor .....	6
<b>2. Removal of the engine from the frame</b> .....	7
<b>3. Disassembly of the SACHS engine</b> .....	10
<b>4. Repairs and adjustment of the sub-assemblies</b> .....	18
4.1 Pre-assembly of the housing section on the magneto side .....	18
4.2 Pre-assembly of the housing section on the clutch side .....	19
4.3 Crankshaft .....	20
4.4 Exchange of main shaft or large shift gear .....	21
4.5 Piston and cylinder .....	21
4.6 Flywheel magneto .....	22
4.7 Carburettor .....	22
<b>5. Reassembly of the SACHS engine</b> .....	23
5.1 Installation of the gear unit .....	23
5.2 Location of the crankshaft .....	25
5.3 Drive and clutch .....	25
5.4 Installation of brake lever on the bracket shaft .....	26
5.5 Piston and cylinder .....	26
5.6 Bosch flywheel magneto LM/UR 1/115/3 RL (/17 R 3) .....	27
5.7 Assembly of driving sprocket .....	28
5.8 Installation of carburettor .....	28
5.9 Lubrication of gear unit .....	29
<b>6. Installation of engine in frame</b> .....	29
6.2 Location of the brake-rod linkage on the engine brake lever .....	29
6.3 Location and adjustment of cable to clutch .....	29
6.4 Location and adjustment of cable to gear shift .....	29
6.5 Location of cable to carburettor .....	30
6.6 Fuel pipe .....	30
6.7 Assembly of pedals .....	30
6.8 Exhaust manifold and silencer .....	30
6.9 Electric connections .....	31
<b>7. SACHS 50 with kick starter</b> .....	31
7.1 Disassembly .....	31
7.2 Reassembly .....	31

# 1. Repair tools

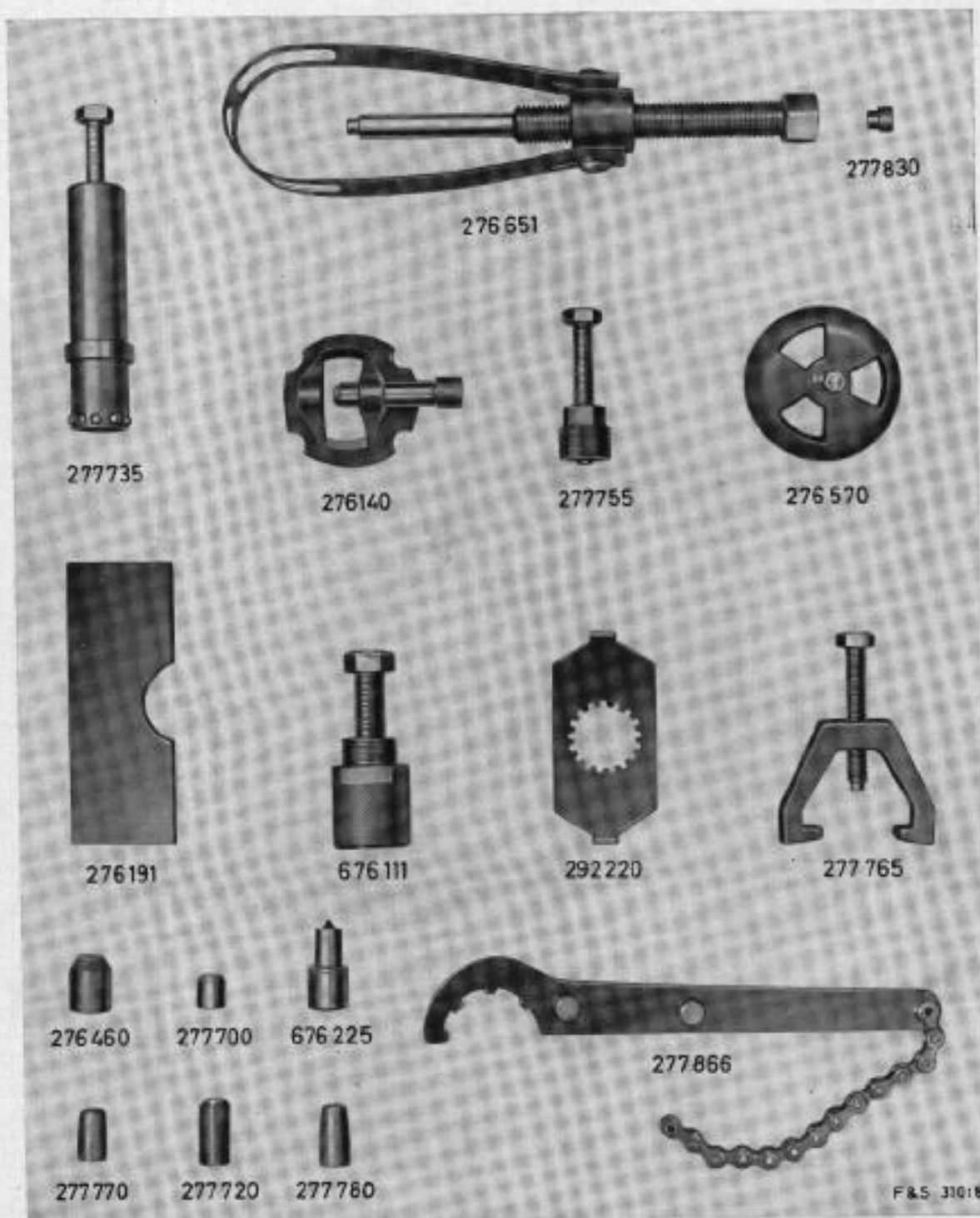

F&S 31018

## 1.1 Standard tools

276 140 Connecting rod holder  
 276 191 Distance plate  
 276 460 Trust bushing  
 276 570 Compressor for clutch  
 276 651 Remover for piston pin

277 700 Adapter with fibre insert for magneto side of crankshaft and sprocket  
 277 720 Adapter for driving side of crankshaft  
 277 735 Ball bearing remover  
 277 755 Remover for magneto flywheel  
 277 765 Remover for sprocket

## 1. 2 Special service tools

F&S 310:20

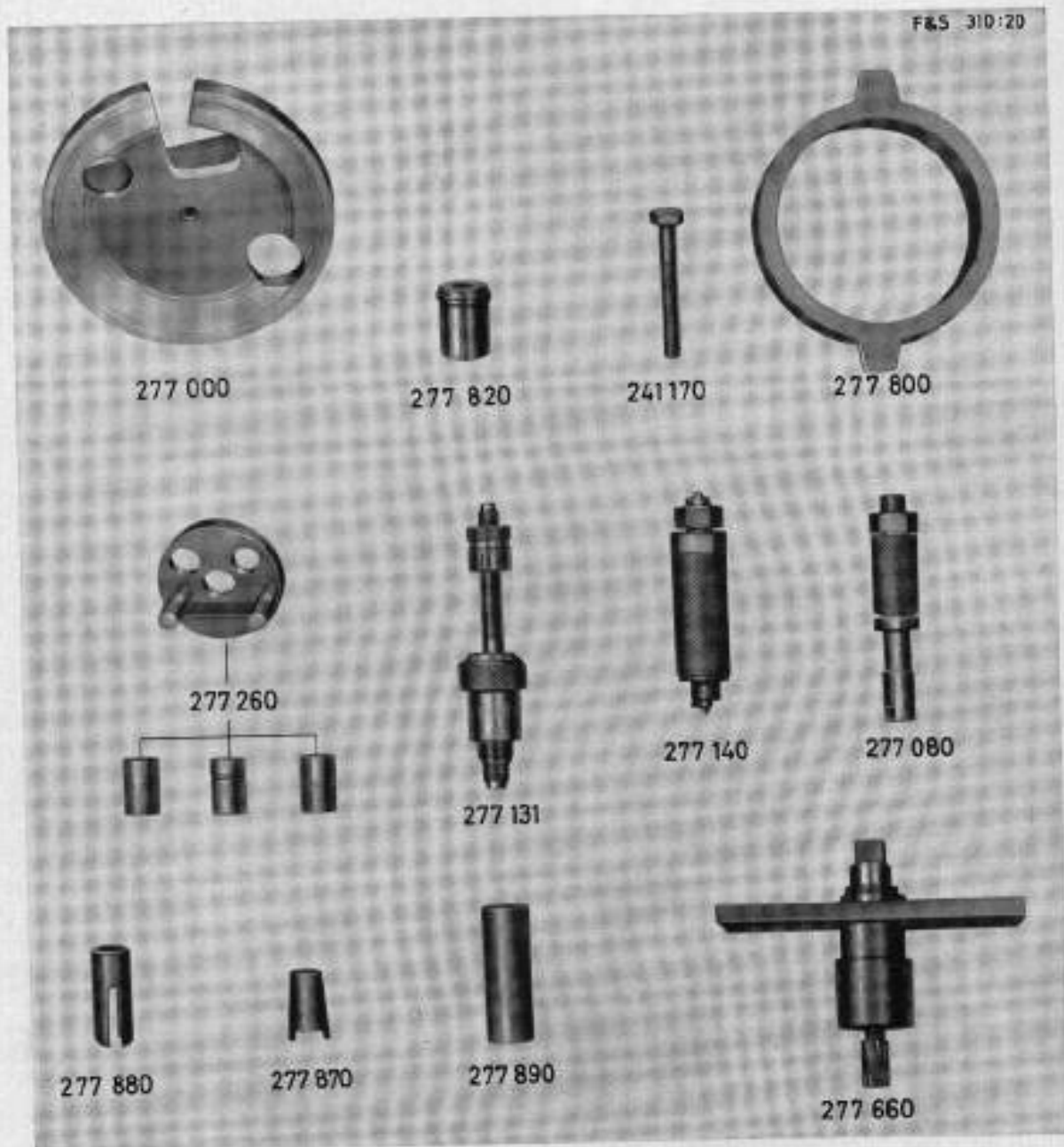

- 241 170 Hexagon head screw for centering plate  
 277 000 Centering plate for dynamo magneto  
 277 080 Remover and replacer, complete, for connecting rod bushing  
 277 131 Gauge complete for spark timing  
 277 140 Remover, complete, for bushing of countershaft  
 277 260 Measuring plate, complete, for end clearance on main shaft and countershaft

- 277 660 Reaming tool for bearing bushing of countershaft  
 277 800 Centering ring for dynamo magneto  
 277 820 Spacer for dynamo magneto  
 277 870 Assembly adapter for assembling main shaft  
 277 890 Spreader for assembling main shaft  
 277 890 Extension tube for assembling main shaft

- 277 770 Extension tube for crankshaft on magneto side  
 277 780 Extension tube for crankshaft on driving side  
 277 830 Reducer for piston pin

- 277 866 Hooked wrench for retaining nut  
 292 220 Retainer plate for clutch  
 676 111 Remover for clutch hub  
 676 225 Guide bolt



### 1.3 F & S compressor

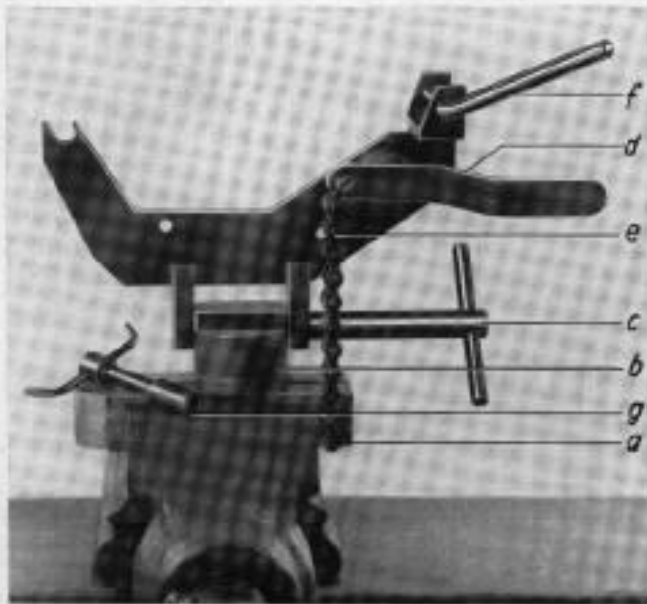

Fig. 3

In order that all repairs and adjustments to SACHS engines can be carried out simply and efficiently, an assembly compressor has been developed with the aid of which all SACHS engines can be disassembled and reassembled.

The assembly compressor No. 276 800 in its basic construction is designed for the SACHS 100 engine. A mounting plate (h), No. 277 840 (Fig. 4), and a supporting bolt (i), No. 277 855 are supplied extra with the basic type No. 276 800 (Fig. 3) for the SACHS 50.

The basic type is clamped in the vise by means of a gripping claw (a). The fact that this device can be rotated and tilted (b, c) means that all tasks can be carried out speedily in full view of the mechanic. The attachable supporting bracket with chain (d, e) enables the nuts to be removed easily from the magneto flywheel and the sprocket.

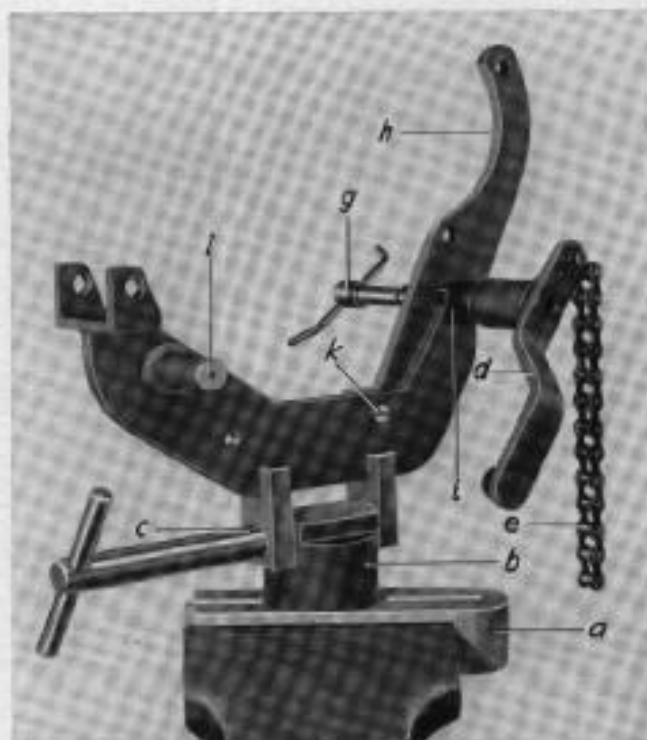

Fig. 4

The mounting plate (h), No. 277 840, is fitted to the basic type compressor, No. 276 800, as shown in Fig. 4, by means of a second supporting bolt (i) in combination with the four-way rim wrench (g), and also by means of a tightening screw (k) with nut. The supporting bolt (i) on the basic compressor should be tightened in the direction of the supporting bolt (i).

## 2. Removal of the engine from the frame

All connections leading to the engine block should firstly be loosened.

2.1 Close the fuel tap (a), unscrew the fuel pipe (b) at the tap which should be cleaned at the same time, or remove the tube at the carburettor (c). (Fig. 5)

2.2 Unscrew the mixing chamber cover (h) at the carburettor, and slide together with the throttle slide (k). If it is not intended to give the carburettor a special check and to clean it, the mixing chamber cover and the throttle slide can be left suspended on the cable (d) in the frame.

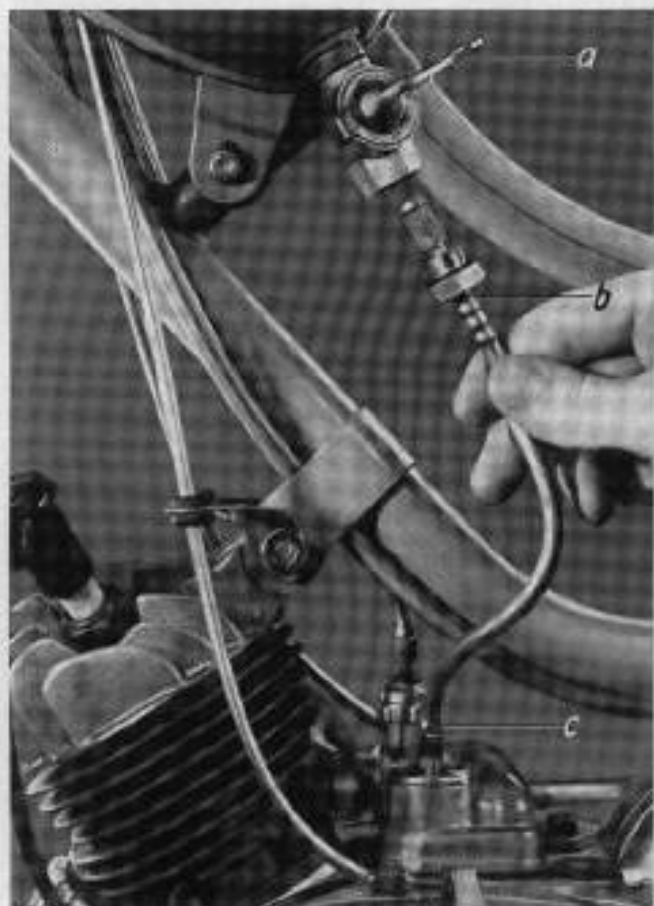

Fig. 5

2.3 Disconnect the cable to the gear shift (engaged in 2nd. speed) at the shift lever (f), and then remove the cable adjuster screw (g) from the guide lug at the engine housing (Fig. 6).

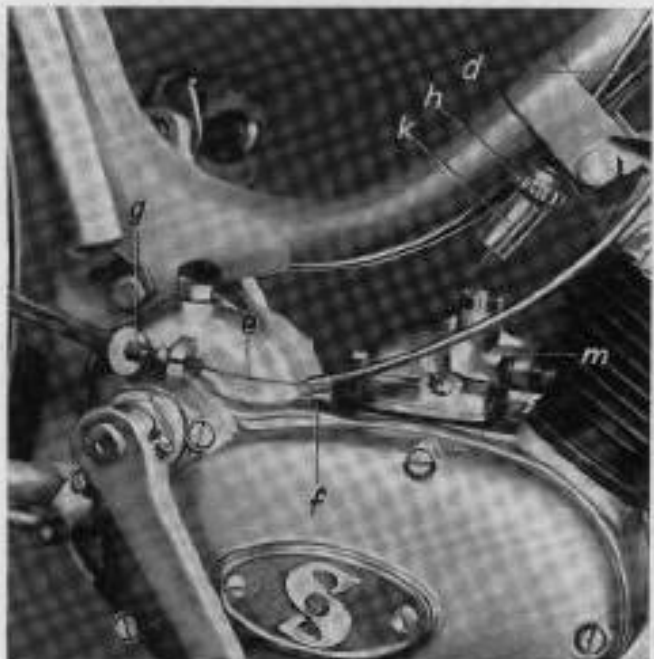

Fig. 6



Fig. 7

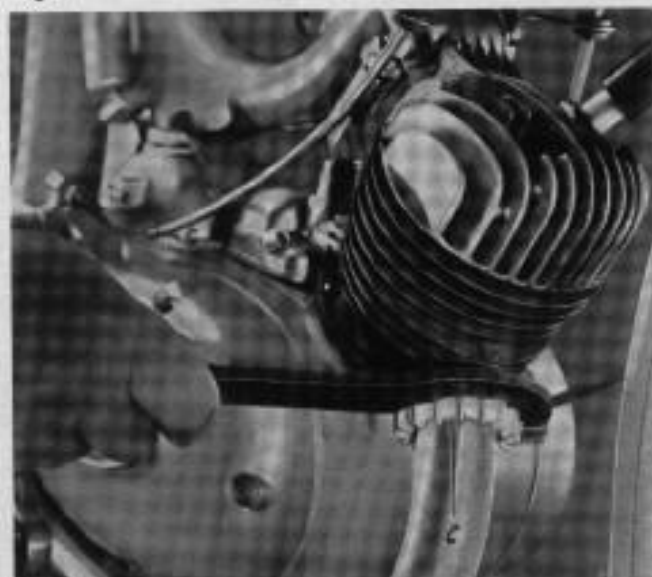

Fig. 8



Fig. 9

2.4 Disconnect the cable (a) of the clutch from the engine clutch lever (b). (Fig. 7)

2.5 Remove the retaining nut (c) to the exhaust manifold. It is advisable at this stage to remove the complete exhaust manifold with the silencer so that it can be cleaned after having been disassembled. (Fig. 8)

2.6 Screw out the sparking plug W 175 T 11. Screw apart both cable clamps, yellow light cable (g) and black short-circuit cable (s), and then remove the cables from the clamps at the engine side. (Fig. 9)



- 2.7** Remove the pedals. Loosen the nut (a) on both pedals, and screw back slightly (screw spanner SW 10). Loosen both cotters by tapping gently with a hammer, remove both nuts, washer and cotters. Subsequently remove left and right pedals (b). Disconnect brake-rod linkage (c) at the engine brake lever (d) after loosening the split pin. (Fig. 10)



Fig. 10

- 2.8** Remove housing cover on the magneto side, loosen, two cylinder head bolts (screwdriver).

Loosen the engine mounting.

Remove the chain guard. Using a screwdriver SW 14, remove the engine mounting bolts (m) with nuts and locking washers. (Fig. 11)

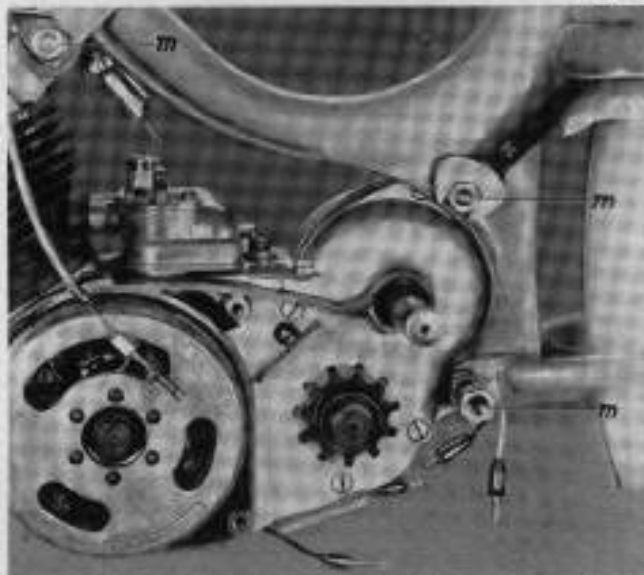

Fig. 11

- 2.9** Drain off the gearbox oil. Using a screwdriver or screw spanner SW 14, remove the oil inspection screw (d, Fig. 9). Remove the oil-drain screw (e, Fig. 9) with the box spanner SW 14. (The gear oil can be drained off more quickly by removing the closure „S” on the housing cover at the clutch side, and by laying the engine on its right hand side so that the oil can run out).

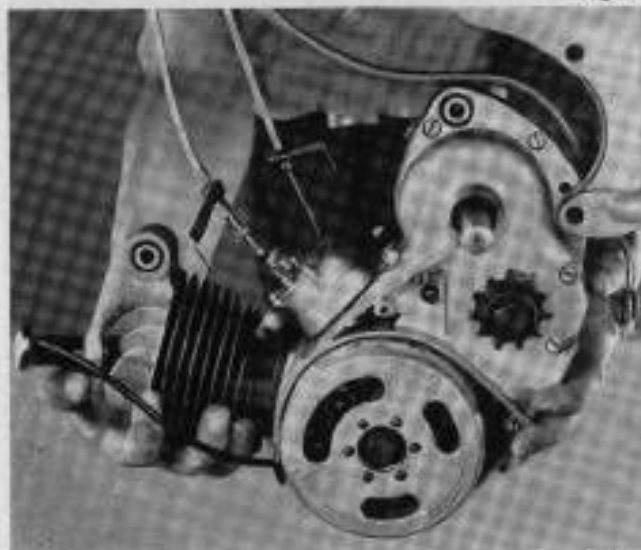

Fig. 12



### 3. Disassembly of the SACHS engine

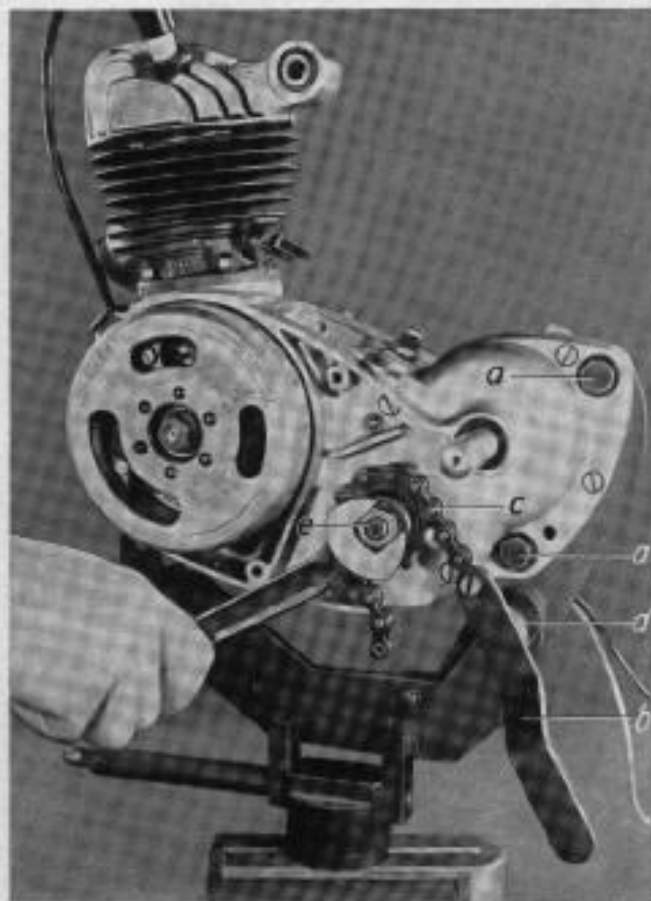

Fig. 13

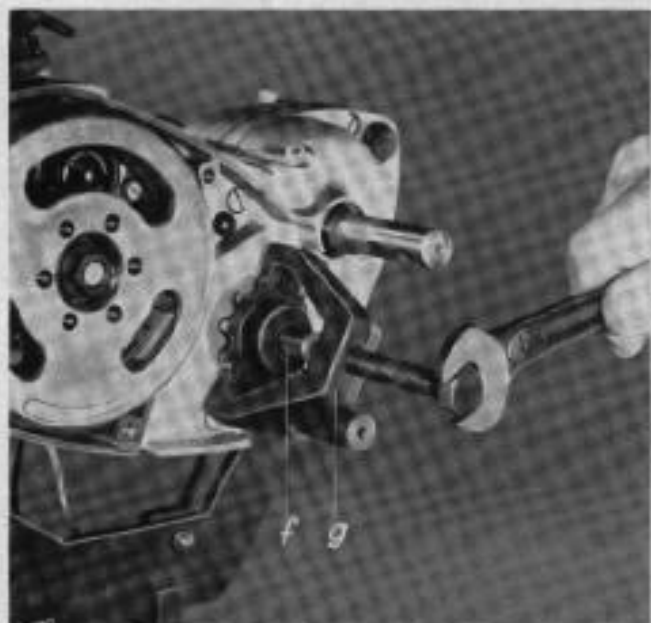

Fig. 14

3. 1 Mount the engine in the F & S assembly compressor. 2 bolts (a) M 8 x 50 with nuts.

3. 2 Remove the carburettor. Remove two nuts M 5 with the screw spanner SW 9. Remove washers, tilt the carburettor upwards and withdraw. Remove the gasket. (For details on the carburettor, see Handbook SACHS 50).

3. 3 Remove the driving sprocket. The housing cover on the magneto side must be removed at this stage, if this has not already been done (see Section 2, Para. 8).

Locate the supporting bracket (b) with chain (c) on the supporting bolt (d), and place the chain over the sprocket from right to left.

Subsequently remove the nut (e) on the main shaft and lift off the spring washer. Remove the supporting bracket (b) with chain. (Fig. 13).

The adapter (f), No. 277 700, with fibre insert is placed on the main shaft to protect the thread of the latter. Using the remover tool (g), No. 277 765, withdraw the sprocket. Subsequently remove the woodruff key. (Fig. 14)

**3.4** Dismantle the ignition system. Locate the supporting bracket (a) on the supporting bolt (b), at the same time inserting the pin (c) in the long slit (d) of the magneto flywheel in such a manner that stress is exerted on the supporting bracket (a) when the retaining nut is loosened.

Loosen the retaining nut (e) by means of a screw or box spanner SW 14. Remove the spring washer located under the retaining nut (e). (Fig. 15)

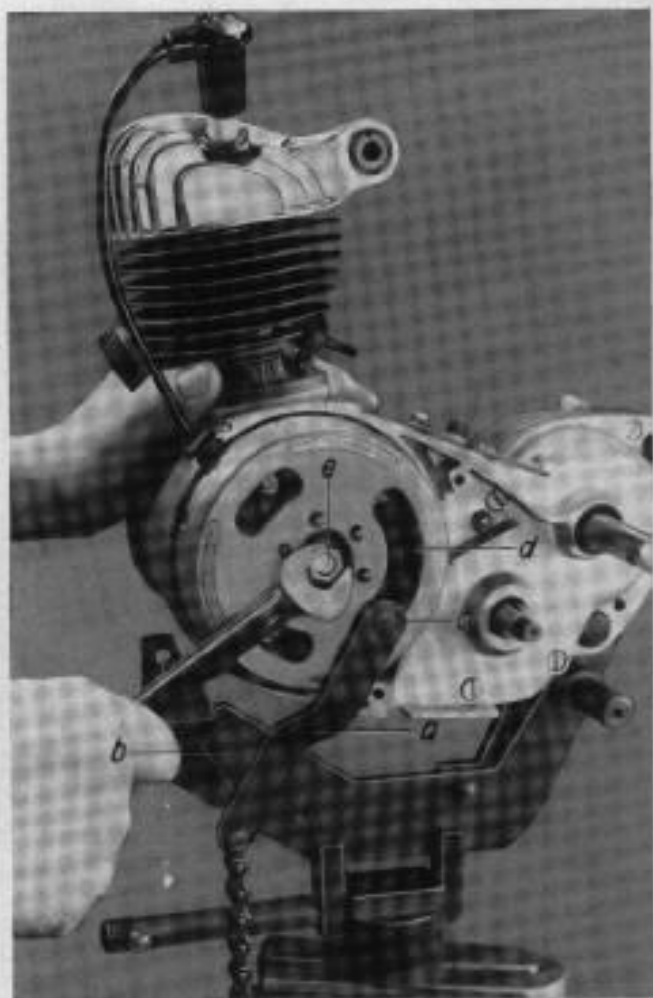

Fig. 15

Remove the magneto flywheel. Tighten the supporting bracket (a). Locate the adapter No. 277 700 with the fibre insert, and withdraw the magneto flywheel using the remover (g), No. 277 755 (Fig. 16)

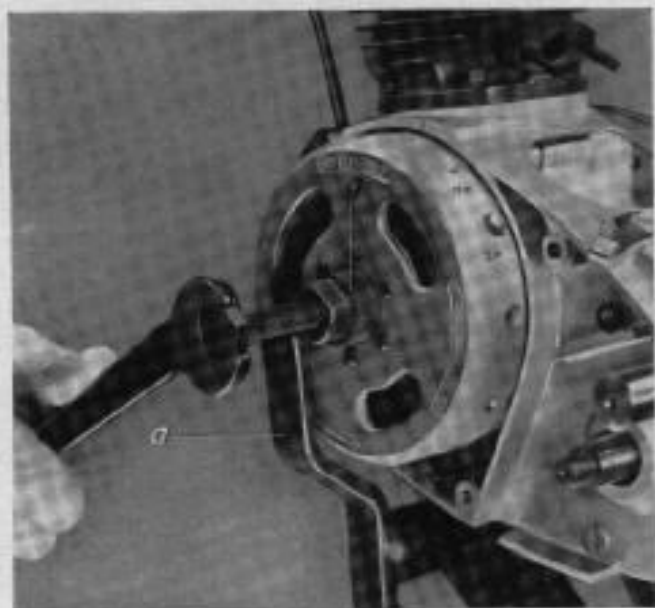

Fig. 16

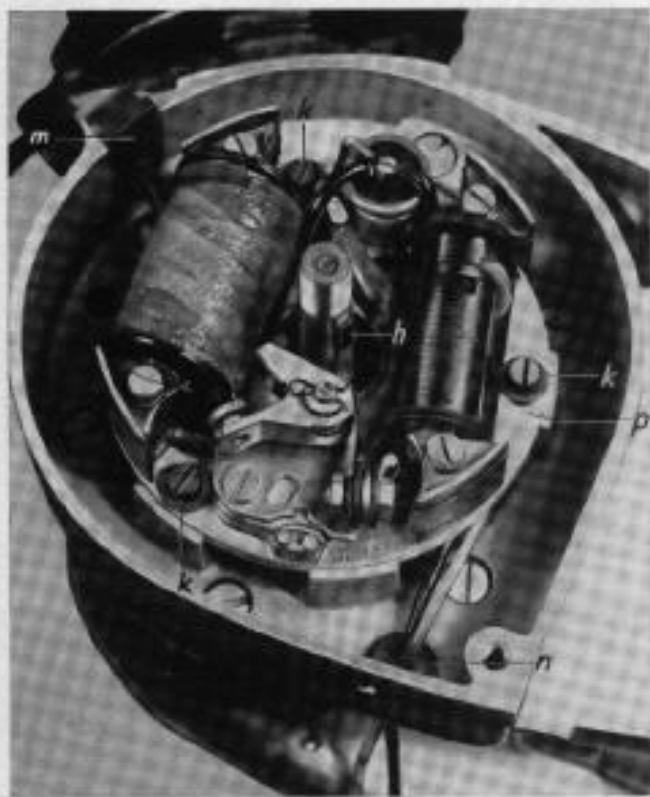

Fig. 17

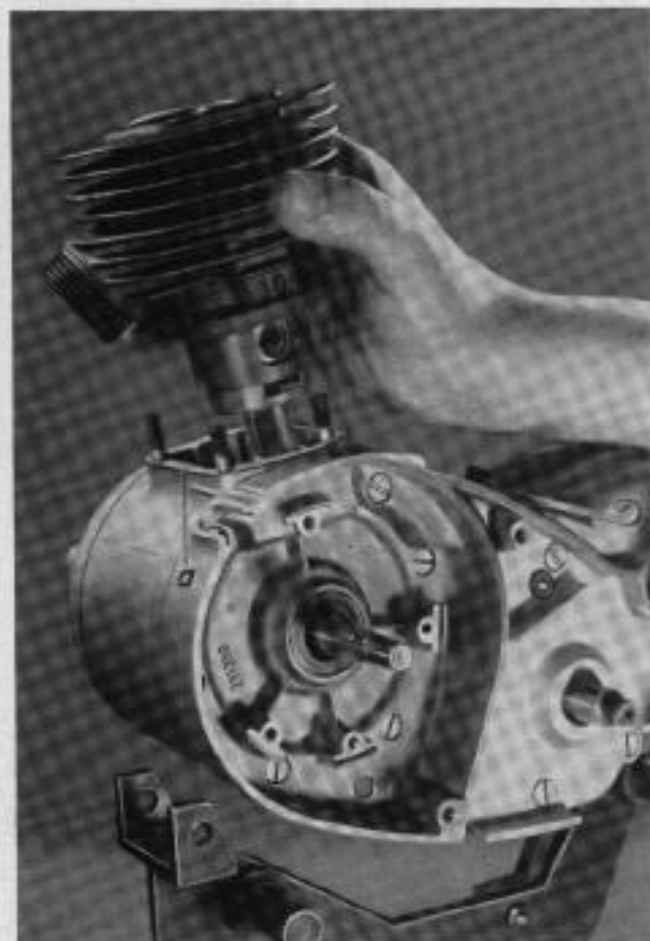

Fig. 18

Do not remove the woodruff key (h) yet, otherwise there is a risk that the windings of the coils will be damaged.

Unscrew the armature base plate (3 screws M 4 (k) with washers and spring washers). Before removing the armature base plate, carefully force the rubber adapters (m and n) of the ignition, lighting and short-circuit cables out of the housing. Remove the armature base plate, and place it together with the magneto flywheel. The woodruff key (h) can now be removed. (Fig. 17)

### 3.5 Remove the cylinder head and cylinder.

Unscrew the cylinder head, four screws M 6 with washers, using a box spanner SW10. Unscrew the cylinder, for nuts M 6 with spring washers, using a screw spanner. Take care not to turn the cylinder when lifting it out otherwise there is a risk of breaking the piston ring. Remove the cylinder base gasket (a). (Fig. 18)



- 3.6 Dismantle the piston. Locate the wood fork. If the gear block is left together, place a duster on it. Remove the gudgeon pin circlip (a) on both sides. (Fig. 19)



Fig. 19

Using the reducer (b), No. 277830, and the remover tool (c), No. 276651, force out the gudgeon pin. Make sure that the piston ring does not fall out unobserved. (Fig. 20)



Fig. 20

- 3.7 Remove the brake lever from the bracket shaft. Using special pliers, remove the retaining ring (h). Remove the shims (k). Remove the split pin (d) from the nut M 20.8 (m), left-hand thread, and unscrew the nut. (Socket wrench SW 26). Remove the brake lever (e) and bearing disk (f), both internally geared. Remove the check plates or shims (g) under the bearing disk. (Fig. 21).



Fig. 21



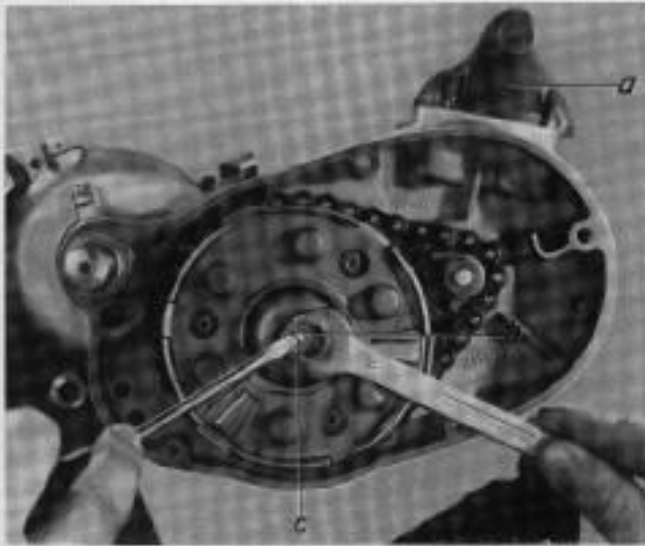

Fig. 22

- 3.8 Dismantle the drive and clutch. Unscrew the housing cover on the clutch side together with the gasket (5 bolts M 6). Locate the connecting rod holder (a), screw out the check nut (b) and the adjusting screw fully. (Fig. 22)



Fig. 23

Screw the compressor (d), No. 276570, into the thread of the thrust disk by hand. Then screw the spring plate, 6 compression springs and the thrust disk with the nut together until the two locking plates (f) can be removed, and the tightened spring assembly can be lifted out. (Fig. 23)

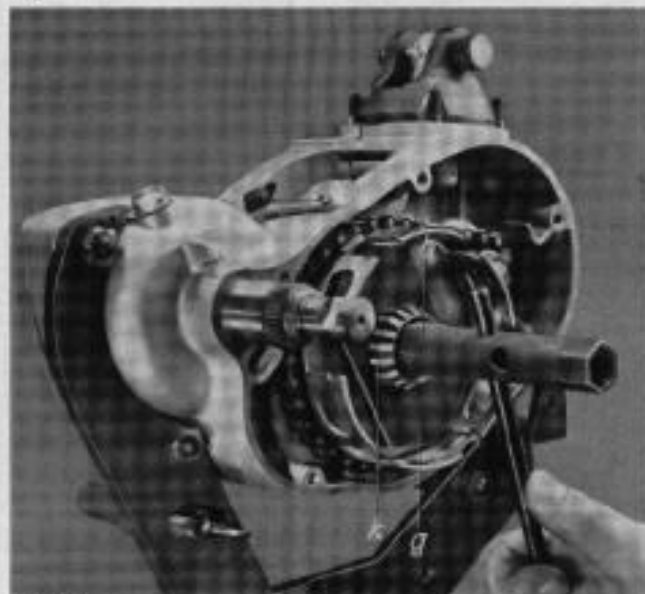

Fig. 24

Slightly slacken the spring assembly until it is replaced by means of the nut (e). Remove the cork and steel disks together with the three-piece clutch pin.

Insert the clutch retainer plate (g), No. 292220. Using a box spanner SW 17, unscrew the nut (h) to the clutch hub (k), and remove the lock washer. (Fig. 24)

Using the remover (m), No. 676 111, without an adapter, withdraw the clutch hub. Remove the retaining plate (g). (Fig. 25)

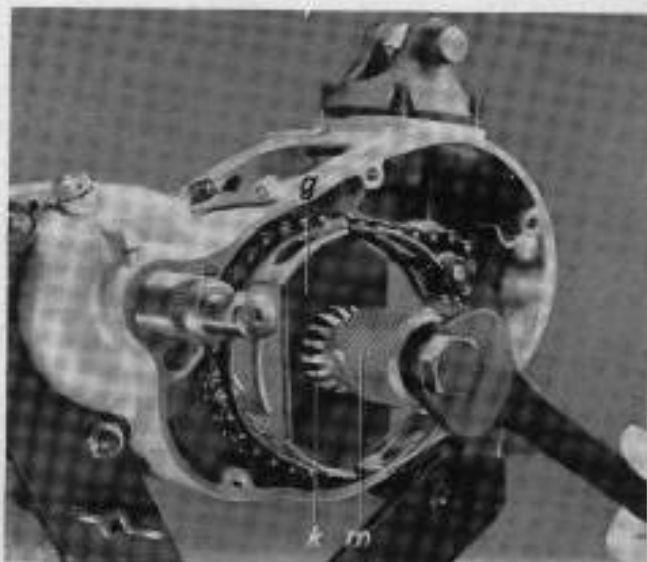

Fig. 25

Remove the woodruff key (a) from the countershaft. Unfasten the locking washer (c) of the nut (b) M 20.8 for the outer race bushing, and unscrew the nut. Lefthand thread (box spanner SW 26).

Loosen the nut M 8 (d) to the main driving gear, and remove using a box spanner SW 14 (right-hand thread). (Fig. 26)

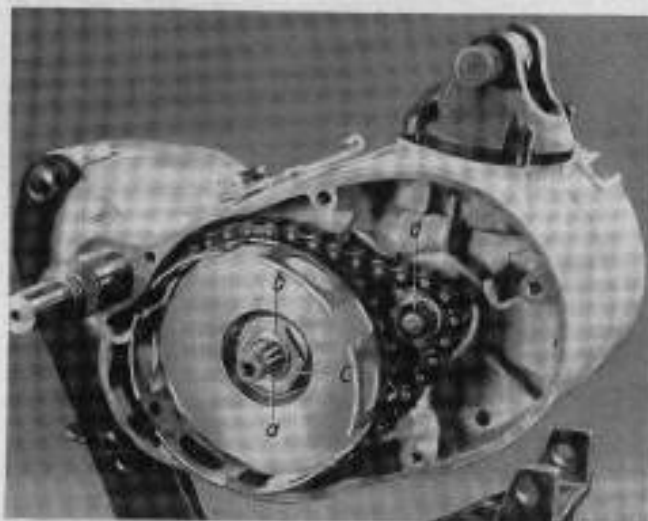

Fig. 26

Lift up the clutch housing (f) with the left hand from the cone of the outer race bushing. At the same time gently tap the large thrust bushing (h), No. 276 460, located on the main shaft, using a hammer. Remove the clutch housing (f) with shock absorber, main driving gear (n) and the chain belt (p) all together. Remove the woodruff key on the crankshaft. Check for the shims under the main driving gear used for adjusting the line of the chain from the clutch housing to the main driving gear. Remove the connecting rod holder (e). (Fig. 27)



Fig. 27

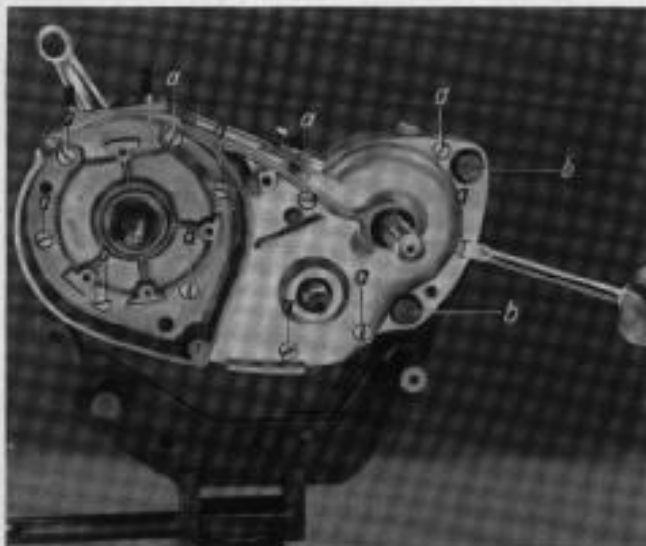

Fig. 28

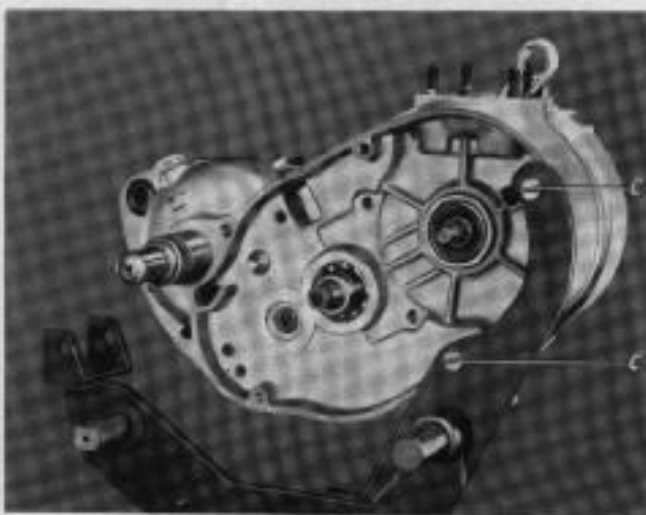

Fig. 29



Fig. 30

- 3.9 Dismantle the gear unit and the crankshaft. Remove eleven screws (a) on the magneto side, using the screwdriver. (Seven screws M6x20, four screws M 6 x 35).

Unscrew both housing sections from the assembly compressor. 2 screws (b) 8 x 50. (Fig. 28).

Screw both housing sections on the cover of the clutch side on the assembly compressor again, using two screws (c), 6 x 20. (Fig. 29)

Exerting the pressure of the left hand on the bracket shaft (d), with the left thumb on the main shaft (e) and the right thumb on the crankshaft (f), lift off the housing section of the magneto side with the finger tips of both hands.

If necessary the housings can be separated from each other by tapping gently with the rubber hammer on the main shaft, crankshaft and bracket shaft. (Fig. 30).

Remove the crankshaft (a). (The crankshaft should not be replaced without the extension tubes, Nos. 277 770/780, because of the risk of damaging the rubber gasket). Using both hands, remove the bracket shaft (b) with sprocket, carrier with brake spring and carrier bushing, main shaft (c) with mounted



large shift gear (25 cogs, 1st speed) and chain belt (d) (28 links), all together. Check for the check plates and shims between the carrier bushing and the housing. (Fig. 31)

Detach the bolt spring (p) with the spring shackle bolt (q) from the shift fork (g) (using round long-nose pliers), and remove from the housing.

Remove in the following sequence the shifting disk (s) with the two slot plates (r) - centre of gravity to the countershaft - small shift gear (e) (23 cogs, 2nd. speed), and the check plate (2 mm thick) under the small shift gear (e).

Remove in the following order the countershaft (f) with star disk, outer race bushing and driven bronze bushing.

Disassemble the shift fork (g) with shift lever (h). Screw out the holding screw M 6 (n) and the oil drain screw M 8 (k), if not already removed. Check for the synthetic rubber gasket with sheet cover and shim washer (m), to the shift lever. (Fig. 32)



Fig. 31

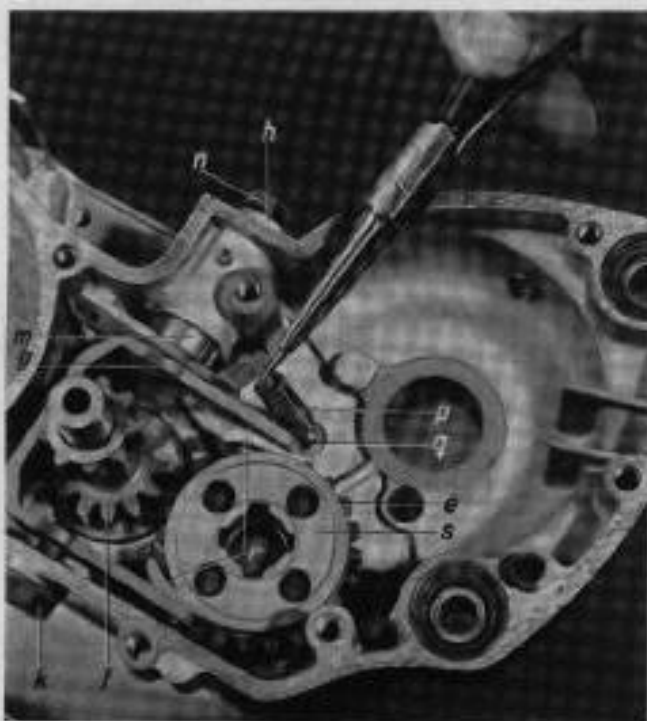

Fig. 32

Unscrew the housing section on the clutch side from the assembly compressor.

3.10 The engine is now completely disassembled. Clean the housing and gear unit sub-assemblies, check the sub-assemblies and replace wherever necessary.

**USE FICHTEL & SACHS GENUINE SPARE PARTS!**



## 4. Repairs and adjustment of the sub-assemblies

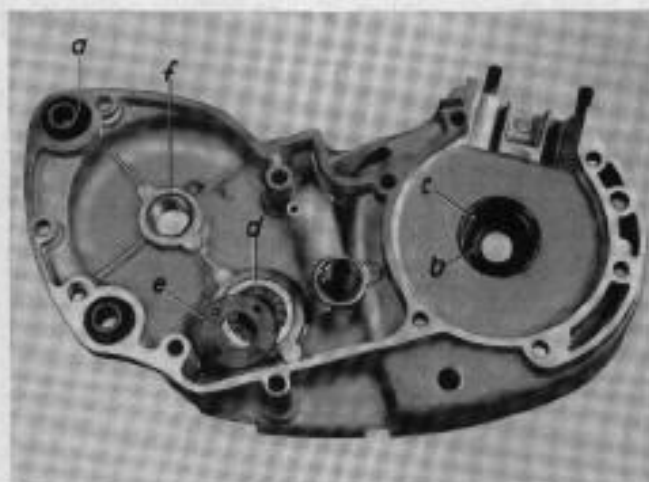

Fig. 33

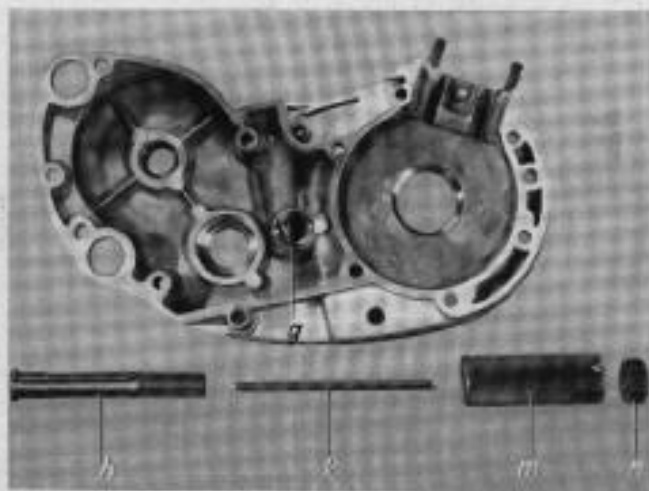

Fig. 34

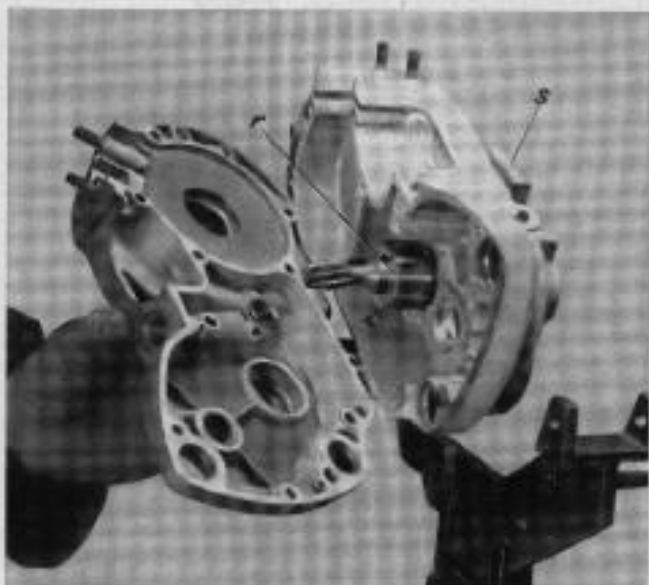

Fig. 35

### 4.1 Pre-assembly of the housing section on the magneto side

#### 4.11 General

Before warming up the housing sections, press out the rubber bearing (a) to the engine suspension. Heat the housing sections to 60 to 70° C, and remove the outer ring by tapping gently with the rubber hammer.

It is advisable to have the new outer ring close at hand and to replace it while the housing is still at the same temperature. This precludes re-heating.

Caution. The housing is electron die-cast, and cannot be welded.

#### 4.12 Bearing-crankshaft

Replace in the following sequence the synthetic rubber gasket (b), 250 900, held in the steel ring (rubber lip facing the crank web), and the outer race of the groove bearing (c) E 15.

#### 4.13 Bearing-main shaft

Press together the synthetic rubber gasket, 250 601 (rubber lip facing the inside of the housing), washer, 244 780, and outer race of the roller bearing, 232 250 (d). Place 15 rollers 4 x 8 mm in hot bearing grease, and cover with the washer (e), 244 780. (Fig. 33)

#### 4.14 Bearing-countershaft

The bronze bushing 233 025 is a part of the housing section. If the bronze bushing is defective, remove it by means of the special remover tool, No. 277 140 (h, k, m, n). Remove the clutch lever with it.

To do this disassemble the special remover tool. Insert the draw-in attachment (h) with the grips in the bronze bushing (g) by overcoming the gripping pressure. Press the pin (k) fully home in the draw-in attachment (h) to stop the two grips from shifting. Remove the bronze bushing (g) by means of the pressure adapter (m) and the nut (n). (Fig. 34)

Insert a new bronze bushing, No. 233 029 (12.8 mm bore) in the housing.

Caution. The oil lubrication groove must be in alignment with the oil lubrication bore in the housing. Bore an oil lubrication hole in the bronze bushing 4 mm in diameter.

Ream the bronze bushing using the special reaming tool (r).

For reaming, the ball bearing outer race - E 15 - to the ball bearing bushing must be removed from the housing section on the clutch side (heat up to 60 to 70° C), and in its place insert the guide piece for the reamer. The reamer is tightened by means of the compressor plate (s) and the nut, M 24 left. Screw the two housing sections together by passing through the fitting adapters. Then ream the bronze bushing to size using the special reamer, (Fig. 35).

#### 4.15 Bearing-bracket

The bronze bushing 232 390 (f) with the synthetic rubber gasket (rubber lip facing the bronze bushing) is a part of the housing section. (Fig. 33).

#### 4.16 Bearing clutch lever

Insert the synthetic rubber gasket 650 170 and the adapter 246 120 together, with the rubber lip facing towards the housing. Then assemble the clutch lever by means of the notched pin and rubber gasket.

#### 4.17 Insert two rubber bearings 260 210 for the engine suspension. (Collar of the steel bushing as the abutment in the frame to the outside of the housing). The insertion of the rubber bearings is the same both for the housing sections on the clutch side and for the cylinder head.

### 4.2 Pre-assembly of the housing section on the clutch side

#### 4.21 General (see Section 4.11)

#### 4.22 Bearing- crankshaft (see Section 4.12)

#### 4.23 Bearing-main shaft Insert washer 244 390 (a), and press in the outer race (b) 232 120. Insert 13 rollers (c), 4 x 6 mm, in hot bearing grease, and cover with washer 244 390 (a). (Fig. 36)

#### 4.24 Bearing-countershaft Insert groove bearing outer race (d) - E 15 - to the ball bearing bushing 286 791. (Fig. 36)

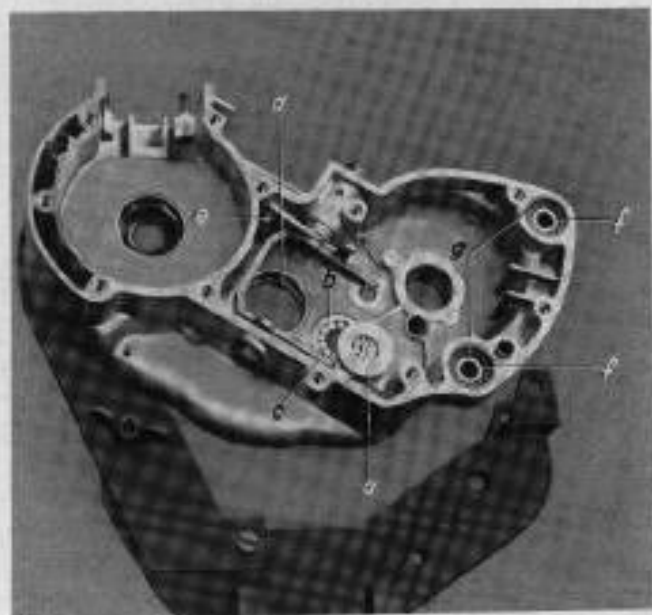

Fig. 36

- 4.25 Bearing for the gear shift lever. Insert the synthetic rubber gasket 650 170 in the adapter 246 120, and press together, with the rubber lip facing towards the housing.
- 4.26 If necessary, insert the notched pin 249 460 (e) 4 x 14 mm for the shift fork stop (part of the housing section).
- 4.27 Insert two rubber bearings 260 210 (f) for the engine suspension. For procedure see Section 4.17.
- 4.28 Insert two wedge plates (g) for the rubber bearings (f). (Fig. 36)

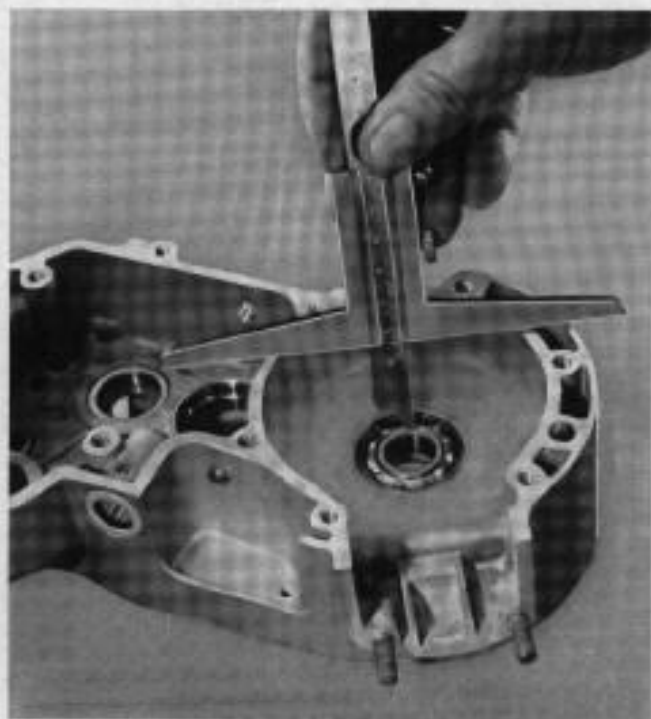

Fig. 37

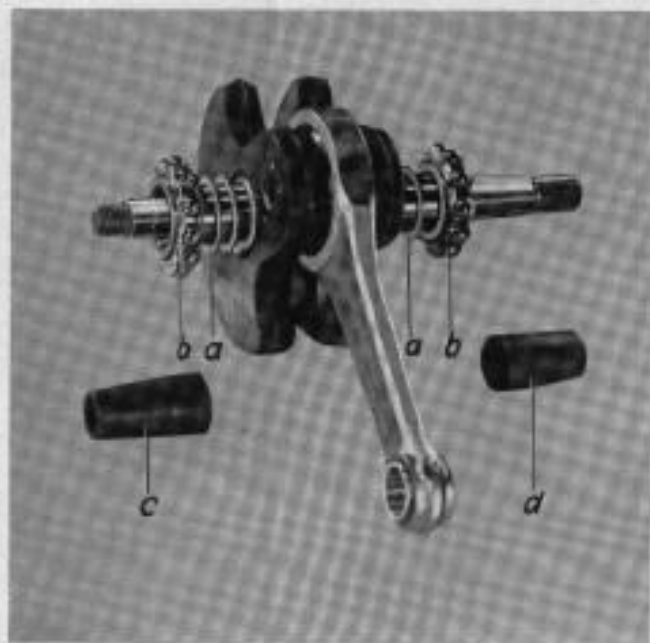

Fig. 38

### 4.3 Crankshaft

- 4.31 Crankshafts which have been repaired at workshops not affiliated to the SACHS service organisation, or which have been cut, welded or soldered, will not be replaced.

Exchanging the connecting rod bushing.

Worn out bronze bushings should be withdrawn by means of the special remover tool No. 277 080. Insert the new bronze bushing No. 283 385, and ream to size using the "Hunger" type special reaming tool.

Exchanging the inner race of the groove bearing. Strip off the ball retainer from the inner race of the crankshaft. Locate the special remover tool No. 277 730 with the adapter No. 277 720, and withdraw the inner race using the setscrew.

- 4.32 Measuring the two housing sections for the installation of the crankshaft. (Fig. 37)

Example:

Measurement of the housing section on the clutch side:	26.10 mm
Measurement of the housing section on the magneto side:	<u>6.10 mm</u>
Housing clearance without gasket:	32.20 mm
Measurement of the crankshaft (recorded electrically):	<u>30.10 mm</u>
Difference	2.10 mm



This difference of 2.10 mm is compensated for on the crankshaft by means of shims (a) distributed equally on both sides behind the ball bearing inner races (b).

The axial clearance of the crankshaft is produced by inserting the housing gasket (0.2 mm).

The new inner races are located on the crankshaft pins in a heated state (60 to 70° C, oil bath) by means of a hand press and a pressure tube. A distance plate must be placed between the two crank webs (preferably distance plate No. 276 191). (Fig. 38)

#### 4. 4 Exchanging the main shaft or large shift gear (Fig. 39)

The following special service tools must be held in readiness: 277 870 assembly adapter (f), 277 880 spreader (a), 277 890 extension tube (g).

4. 41 Disassembly. Slide the spreader (a) onto the main shaft. Then tap together on a hardwood base in the direction of e. As a result of the tapping, the circlip (c) is forced apart and it slides out of its retaining groove over the spreader.

Remove the spreader (a) with the circlip (c) and the large shift gear (d) from the main shaft (b).

4. 12 Assembly: Slide the large shift gear (d) (25 cogs) correctly onto the main shaft, locate the assembly adapter (f), locate the circlip (c) with both spring ends on the ground sliding surface of the assembly adapter (f), and insert into the groove of the main shaft (b) with the extension (g). Check for proper location.

#### 4. 5 Piston and cylinder

Cylinders which have more than two broken-off fins, or which have been welded or soldered, will not be exchanged.

The tolerance measurements of the cylinder bore are correspondingly marked by the colours white = plus and red = minus in the induction part of the cylinder and on the piston. Accordingly, a red-marked cylinder is matched by a red-marked piston, and a white-marked cylinder by a white-marked piston.

This arrangement applies in principle to all engines irrespective of whether the cylinder is normal or reground.

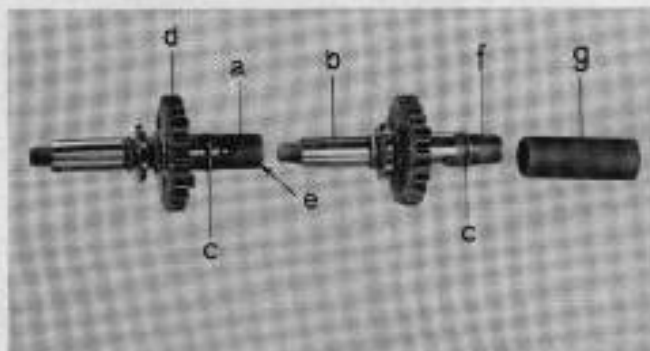

Fig. 39

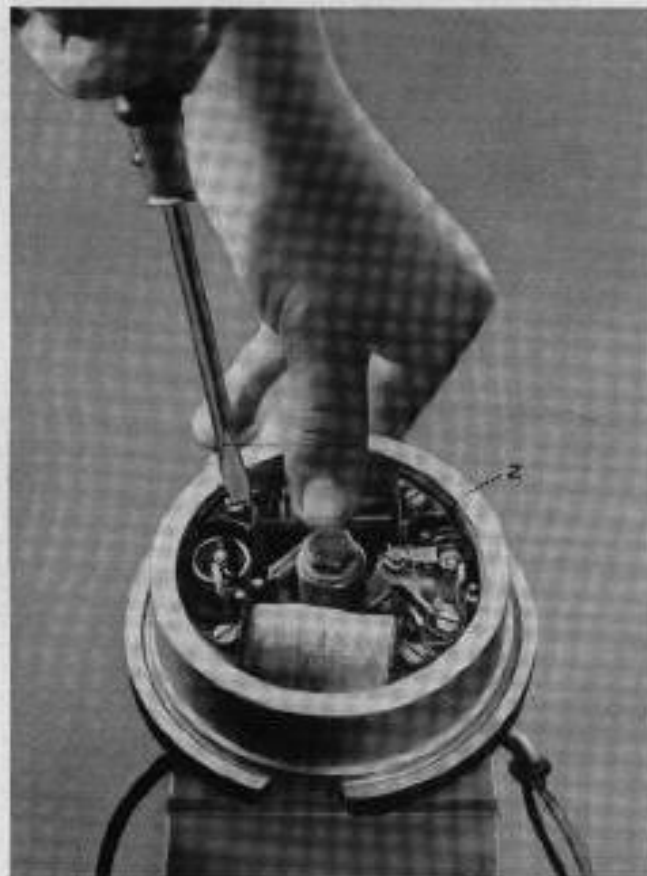

Fig. 40



#### 4. 6 Flywheel magneto (Fig. 40)

4. 61 Repair of the ignition coil and lighting coil. Insert the armature base plate in the centering plate 277 000, and tighten gently using the spacer 277 820 and the hexagon head screw 241 170. When inserting the armature base plate, lead the lighting, contact breaker and ignition cables through a corresponding bore in the centering plate. Defective lighting or ignition coils should be removed. Insert a new lighting or ignition coil, locate the centering ring (277 800 (z)), and press the coil onto the centering ring using the thumb and the index finger. Consequently after removing the centering ring, the precise air gap is produced between the armature core and the magneto flywheel. If necessary, clamp the ignition cable to the tip of the ignition coil, but do not solder. Work carefully so as not to damage the winding.
4. 62 Exchanging the condenser. Unsolder the contact breaker cable and the ignition coil cable. Tap the defective condenser out of the armature base plate, using a piece of round wood. Remove calked joints pressed into the bore with a round file. Insert the new condenser and calk again lightly and carefully. Solder on the contact breaker cable and ignition coil cable again.
4. 63 Exchanging the contact breaker. Screw off the contact breaker cable. Check for the sequence of the insulation at the contact plate. Remove the contact breaker lever at the shoulder stud (clamping spring). Screw off the contact plate. Assemble the new parts in the reverse sequence. Check that the insulation at the contact plate is correct and that the contact breaker points are exactly opposite each other. Apply a little hot bearing grease to the lubricating felt.

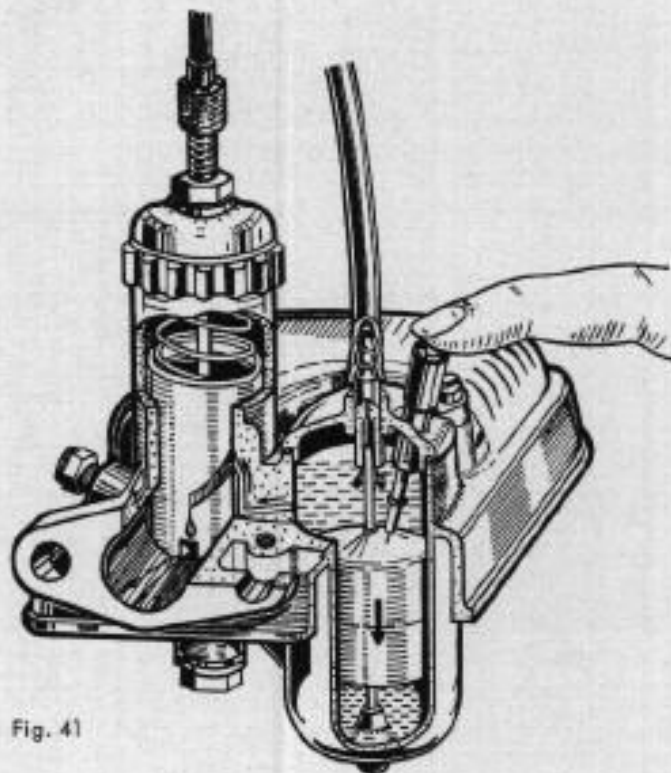

Fig. 41

filter element should then be washed out well in petrol, immersed in motor oil and allowed to drain off.

Adjustment of the contact breaker in the centering device. The fibre button of the contact breaker lever is placed on the distance piece (diameter corresponds to the hub in the magneto flywheel). By adjusting the contact plate, the contact breaker can be set at the specified gap of 0.3 to 0.4 mm.

#### 4.7 Carburettor

The intervals for servicing the air cleaner fitted to the bottom of the carburettor will depend upon the amount of air drawn in by the engine, and in certain instances the cleaner may have to be serviced a frequent intervals. To do this the carburettor is unscrewed at the cylinder, the spring clip is removed, and the air cleaner detached. The

The carburettor body should also be washed well with petrol. To do this, remove the jet and the float, and screw out the plug at the mixing chamber underneath the throttle slide.

The jet can be cleaned without removing the carburettor. Merely the jet which is accessible from outside is screwed out, blown out with air, cleaned and washed out. When all the parts have been cleaned, reassemble the carburettor, and if necessary screw back onto the engine.

## 5. Reassembly of the SACHS engine

### 5.1 Installation of the gear unit

Screw the housing section on the clutch side to the assembly compressor, using two cylinder head screws M 6.

Insert the shift lever (h) with spring plate through the rubber gasket already located, and then screw together with the shift fork (g) and the packing ring (m) using the hexagon head screw (n) and the spring washer.

Screw in the oil drain screw (k) - lead screw for the shift fork - with the gasket. Check for easy movement. If necessary adjust the shift fork.

Locate the outer race bushing with bronze bushing, star disk with countershaft (f).

Insert the check plate (2 mm thick) and the small shift gear (e) (23 cogs, 2nd speed), using the guide bolt No. 676 225. Then assemble the two slot plates (r) - with the centre of gravity in the direction of the countershaft (f) - and the shifting disk. Locate the spring shackle bolt (q) in the housing and the bolt spring (p) in the shift fork (g) (Fig. 42)

To adjust the line of the chain, locate the main shaft (a) with mounted large shift gear (25 cogs, 1st. speed). Insert the carrier bushing and check plate (1 mm) and at

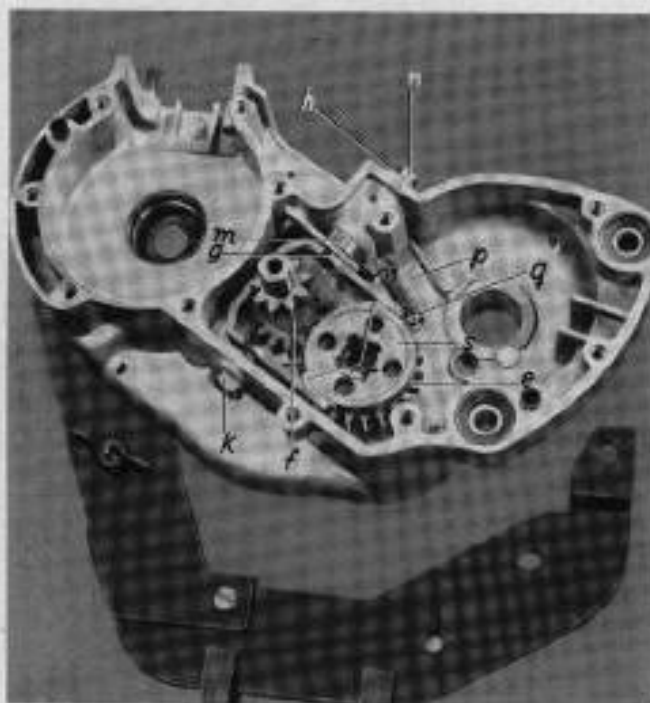

Fig. 42

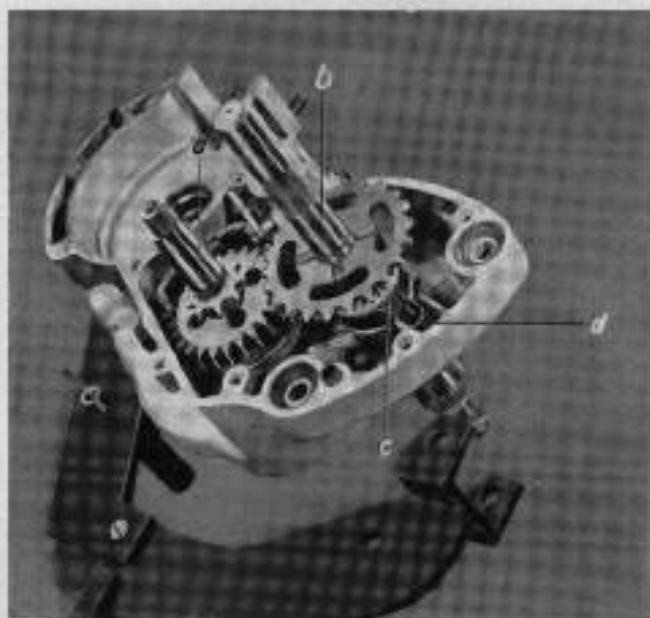

Fig. 43



Fig. 44



Fig. 45

should be inserted between the main shaft and countershaft and the housing section of the magneto side.

## 5.2 Replace the crankshaft

To avoid damaging the synthetic rubber gasket when replacing the crankshaft, the extension tube No. 277 780 should be located on the short crankshaft pin (driving side). Also locate the extension tube No. 277 770 on the long crankshaft pin (magneto side) (see Fig. 38, parts c and d), and tighten the housing section of the magneto side with gasket and fitting adapters using 7 screws (6 x 18) and 4 screws 6 x 30.

the same time make certain that the synthetic rubber gasket and the 1.5 mm thick check plate are located in the carrier bushing.

Then insert the carrier (c) with brake spring (d). The brake spring U-bolt should be located in the guide arm of the housing. Finally replace the bracket shaft (b) with sprocket (without chain). (Fig. 43). Adjust the line of the chain (a) by means of the shim (b) under the sprocket of the bracket shaft. Use a bevelled steel straight edge or slide-rule caliper for measuring. After the line of the chain has been adjusted, assemble the sprocket on the bracket shaft together with the corresponding check plates or shims and the retaining ring. The end clearance must be 0.1 to 0.2 mm. Subsequently install the bracket shaft with the sprocket and the main shaft together with the chain.

The main shaft has a clearance of 0.1 to 0.2 mm, and the countershaft 0.05 to 0.1 mm. To measure the clearance, temporarily screw on the housing section of the magneto side together with the gasket and the two fitting adapters. The end clearance is determined by means of the measuring plate No. 277 260 (Fig. 45). If an adjustment is necessary after the housing section of the magneto side has been removed again, then shims



Before reassembling, check that the roller bearing and the shims are complete.

Both housing sections on the assembly compressor should be reset (Fig. 27).

### 5.3 Drive and clutch

**Caution:** Always degrease the cone of the outer race bushing and the cone in the clutch housing before assembling.

Locate the clutching housing and the main driving gear without the woodruff key and without the chain to balance the line of the chain (a), and adjust by locating shims (b) under the main driving gear. Locate the woodruff key to the main driving gear, and then assemble the clutch housing with the main driving gear and the chain belt. The chain should not be too tight, and must have enough play for it to be moved 5 mm in an upward and downward direction when it is still (Fig. 46).



Fig. 46

Locate the connecting rod holder. Tighten the clutch housing with the locking washer and nut, M 20.8 left, with the shoulder facing downwards. Locate the split pin.

Tighten the main driving gear with the locking washer and the nut, M 8 (right), and locate the split pin.

Insert the woodruff key in the countershaft. Degrease the cone of the countershaft and the cone of the clutch hub. Locate the clutch hub and tighten with the nut M 12 and the lock washer (Use the clutch retainer plate and the box spanner SW 17).

Insert the three-piece clutch pin with intermediate roller oiled. Locate one cork disk, one steel disk and then one cork disk, insert the spring assembly (thrust disk, 6 compression springs and spring plate) tightened together by means of the special tool. Locate the two locking plates, and remove the compressor tool. Check that the two locking plates are properly located.

Adjust the clutch. Screw in the clutch adjusting screw M 6 with check nut, and adjust the clutch. The play at the clutch lever should be 8 to 10 mm. The clutch can be readjusted at any time with the engine mounted, through the cover marked »S«.

Remove the connecting rod holder. Locate the housing cover on the clutch side together with the gasket. Check that the synthetic rubber gasket to the carrier bushing is located. Tighten the housing cover with 5 screws M 6.



#### 5.4 Replace the brake lever on the bracket shaft (see Fig. 21, Page 13).

0.1 to 0.2 mm end clearance. Select shims (g) of a thickness which will ensure the end clearance will be maintained, and locate them on the ground shaft - but under no circumstances in the recessed groove - of the carrier bushing. Locate the geared bearing disk (f) and then the geared brake lever (g), tighten the locking washer (d) and the nut (m), M 20.8 left, with the shoulder facing downwards, and trim the locking washer. The bracket shaft also has a clearance of 0.1 to 0.2 mm. The existing clearance should be adjusted by means of the corresponding shims (k). Subsequently locate the retaining ring (h), 1 or 1.5 mm thick, depend upon the width of the ring groove.

#### 5.5 Piston and cylinder

Locate the cylinder base gasket (a) - see Fig. 18, Page 12 - to correspond with the two return passages. Beforehand scrape off remaining housing gasket parts. Heat the piston to 60 to 70° C, and locate on the connecting rod using locating bolts (bolts from the connecting rod holder). The arrow on the piston must be pointing to the front. Subsequently insert the gudgeon pin by hand, and secure. Check that the gudgeon pin circlips are properly located. Should there be any difficulty in inserting the gudgeon pin by hand, then use the remover No. 276 651 with reducer No. 277 830 (see Fig. 20, Page 13).

Insert the wood fork for the piston bearing. Locate the oiled cylinder without turning it, and tighten with 4 nuts M 6 and lock washers, crosswise. When locating the cylinder, take care not to damage the piston ring because of the risk of breakage.

Tighten the cylinder head with 4 screws M 6 and washers, crosswise. Before finally tightening check that the suspension lug is in alignment with the two suspension lugs on the housing (Fig. 47).

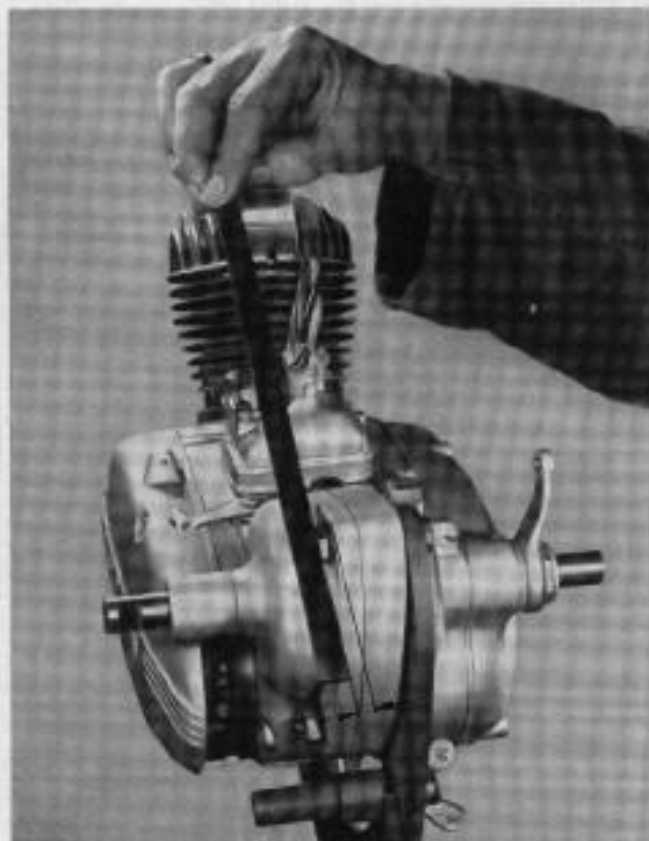

Fig. 47

#### 5.6 Bosch flywheel magneto LM/UR 1/115/3 R1(/17R3)

The flywheel magneto is a generator of alternating current, and requires no maintenance. The one unit contains all the necessary electric parts: ignition coil (a), contact breaker (b), condenser (c), lighting coil (d), magneto flywheel (e). (Fig. 48).

##### 5.61 Assembly

Insert the woodruff key in the crankshaft. Locate the armature base plate with the round rubber adapters for the lighting cable (yellow) and the contact breaker cable (black), also the oblong rubber adapter for the ignition cable, with the curvature to the front (see Fig. 17, Page 12), and tighten with 3 screws M 4, washers and spring

washers. Check for the mark cut (p) (Fig. 17) of the first adjustment.

Degrease the cone, locate the magneto flywheel, and after setting the ignition timing tighten with a collar nut M 10 and lock washer, using the supporting bracket of the assembly compressor (see Fig. 15, Page 11).

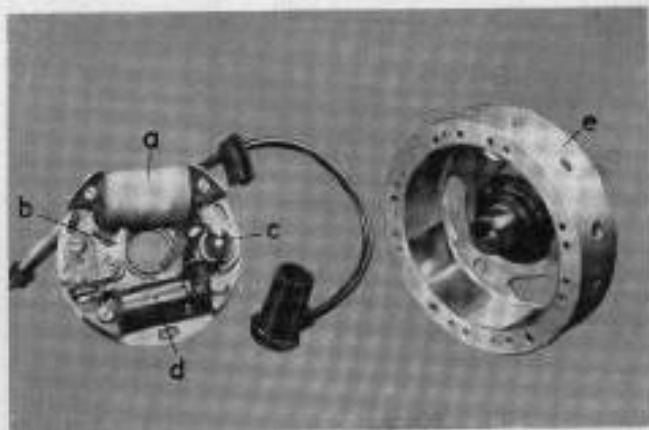

Fig. 48

#### 5.62 Setting the ignition timing

Assemble the armature base plate and magneto flywheel as described in 5.61. Determine the T.D.C. by means of the gauge No. 277 131. Mark the housing and magneto flywheel with the letter «O» (Fig. 50), using a chisel cut. Set the time of ignition at 2 to 2.5 mm before T.D.C. This is done by turning the magneto flywheel in the opposite direction of rotation. The magneto flywheel should be marked at the ignition point with the letter «M» (time of ignition) by means of a chisel (Fig. 51).

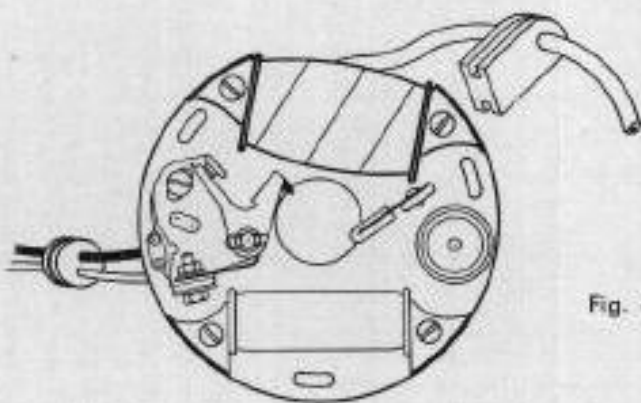

Fig. 49

Set the pole piece-armature core gap at 8 to 12 mm by turning the armature base plate. If necessary, loosen the 3 fixing screws (k) - Fig. 17, Page 12 - of the armature base plate, turn the base plate correspondingly, and then tighten up again (Fig. 52).

Adjust the contact breaker gap at 0.3 to 0.4 mm. In doing this, check that the contact breaker points are still closed at the time of ignition (mark «M») (Fig. 52).

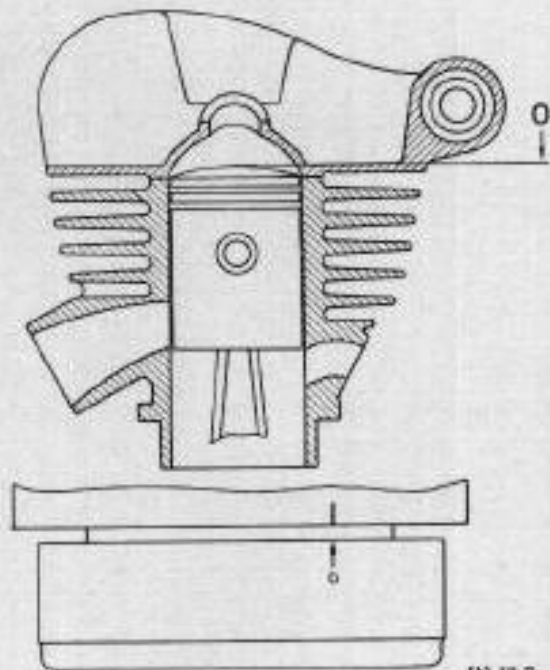

Fig. 50

#### 5.63 Screw in the sparking plug W 175 T 11 with gasket, and connect.

Fig. 50

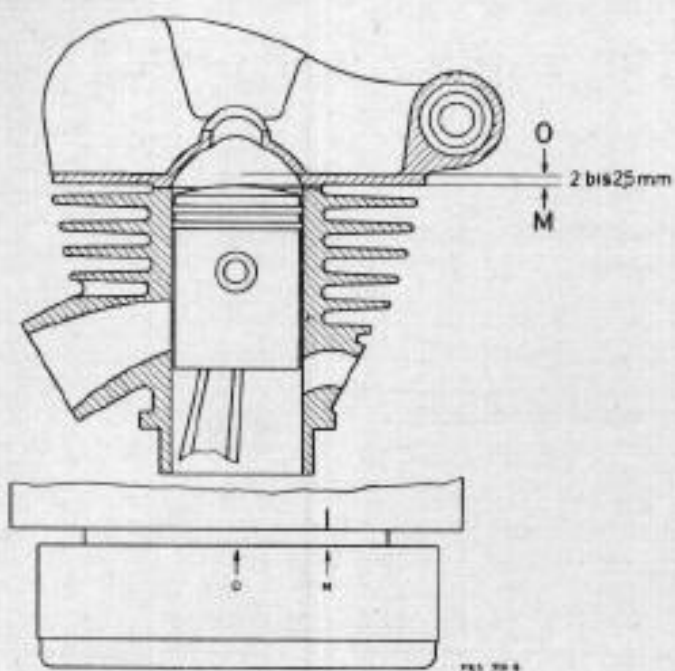

Fig. 51

### 5.7 Assemble the driving sprocket

Degrease both cones.

Locate the woodruff key in the main shaft.

Locate the sprocket, and tighten with nut M 10 and spring washer. To tighten up, use the supporting bracket with chain belonging to the assembly compressor.

Screw on the housing cover of the magneto side, using 2 screws M 6.

### 5.8 Locate and screw on the carburettor

Locate the plastic flange gasket. Insert the carburettor in the stud screws. Locate the washers with the steel side facing the nut. Tighten with two nuts M 5.

### 5.9 Lubrication of the gear unit

Screw in the oil check screw. Pour in 200 ccs of »SACHS 50/150/175 Gear Oil« through the oil filler screw or through the closure »S« on the clutch housing cover. Then tighten up the screws again.

Remove the engine from the assembly compressor.

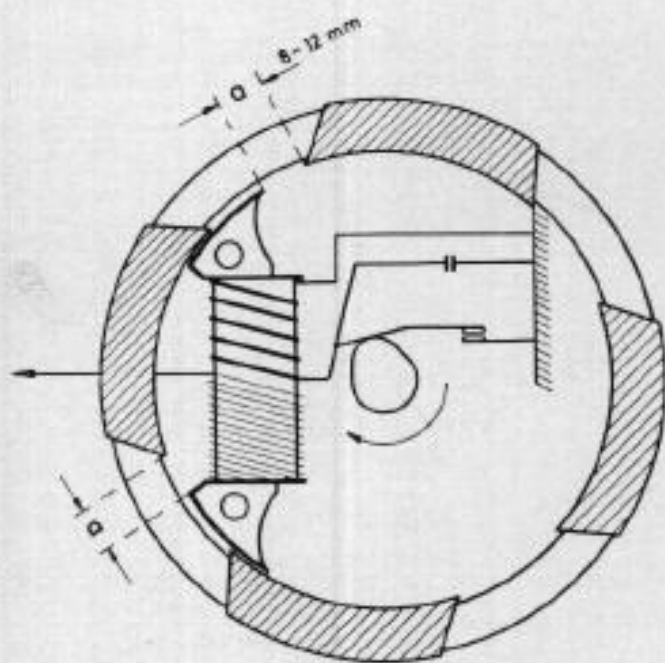

Fig. 52



F&S 310-5



## 6. Installation of engine in frame

**6.1** Tighten the engine by means of the 3 mounting bolts, nuts and locking washers. (Fig. 11)

**6.2 Location of the brake-rod linkage on the engine brake lever.**

Locate the washers, and secure with split pin (Fig. 10)

Locate the chain to the rear wheel, and lock by means of chain fastening. The locking spring must point with the closed side in the rotating direction of the chain.

**6.3 Location and adjustment of cable to clutch.**

Attach the cable for the clutch to the engine clutch lever (a), and adjust the clearance (c) at the steering clutch lever by means of the cable adjuster screw (b). This clearance should be between 1 and 3 mm. The clearance (l) at the engine clutch lever itself amounts to 8 to 10 mm. (Fig. 53).

**6.4 Location and adjustment of cable to gear shift (Fig. 54)**

Screw the cable adjuster screw (c) in the guide lug on the engine housing. Insert the cable (d), oiled, through the cable adjuster screw (c), the gear shift lever (e), the Bowden coil (f) and the shift control grip (g).

Fig. 54 illustrates both possibilities for locating the cable, although we would recommend using the left-hand assembly if possible. Engage the 2nd. gear. There should be a slight amount of play on the Bowden coil, which can be felt when engaging the 2nd. gear. If necessary reset the adjuster screws (c).

Engage in neutral.

Pull out the clutch, turn the rear wheel and slowly engage in 1st. gear by means of the shift control grip until there is slight interlocking of the gears (shift bolt rubbing on the shifting disk). The position of the mark on the shift control grip should be checked in this case between 0 and 1st speed.

In the same manner engage 2nd. gear from neutral.

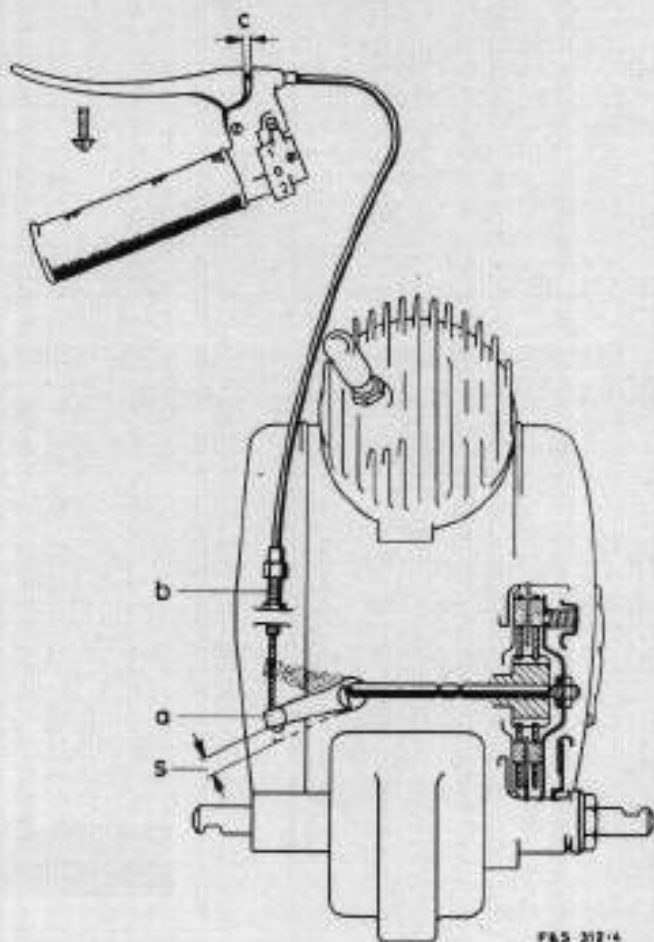

Fig. 53

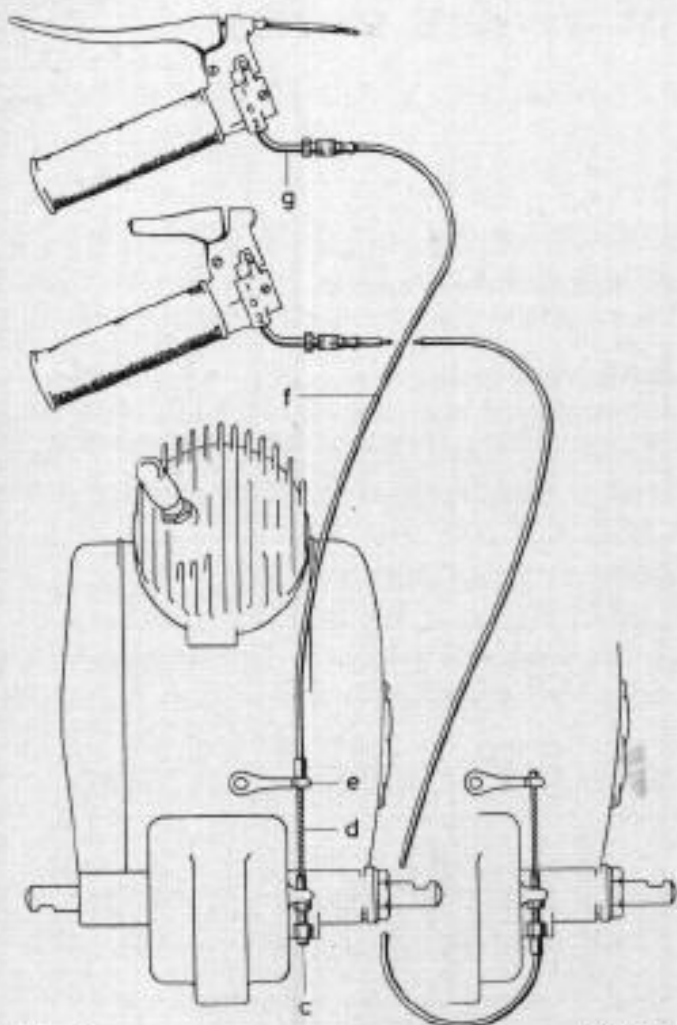

Fig. 54

FAS 311-2

Then check the position of the mark on the shift control grip when the gears start to interlock. Differences in the shifting motion of the neutral gear from 0 to 1st. or 2nd. gear should be corrected at the cable adjuster screw (c) in order to eliminate gear shifting difficulties from the very outset.

#### 6.5 Location of cable to carburettor (Fig. 6, Page 7)

Screw on the mixing chamber cover (h) with the throttle slide (k) at the carburettor (m).

#### 6.6 Fuel pipe

Connect the petrol pipe to the petrol tap, or attach the tube at the carburettor.

#### 6.7 Assembly of pedals

Locate the pedals on the left and right-hand side, and assemble with cotters, nuts and washers.

#### 6.8 Exhaust manifold and silencer

Tighten up well the cleaned exhaust system, locating the retaining nut and gasket.

Make a close check that the silencer and manifold are perfectly sealed.

#### 6.9 Electric connections

Connect both cable clamps for the lighting cable (yellow) and the shortcircuit cable (black), and screw together.

## 7. SACHS 50 with kick starter

### 7.1 Disassembly

Remove the kick starter crank (hexagon head screw M 6 with lock washer). Remove the shims for end clearance from the kick starter shaft. Remove the rosette nut (a) with the brake spring (b) from the kick starter axle (c). Remove the complete kick starter assembly, and dismantle as required. Remove the main shaft.

### 7.2 Reassembly

Locate the kick starter gear (d) on the kick starter axle (c). Measure for correct end clearance of 0.1 to 0.2 mm. If the end clearance is larger, locate shims (e). Replace the retaining ring (f); the gear is now firmly located.

Insert the kick starter spring (g) in the spring collar (h) and cover with the spring drum (k).

Locate the complete spring collar on the serrations of the kick starter axle, and replace the internally geared check plate (m).

Insert the kick starter axle with the complete starter assembly so far in the bearing bore that the starter spring can be stretched, yet at the same time located in the guide arm (n). When the spring is stretched, the complete kick starter assembly should be inserted in the bearing.

Place the rosette nut (a) with the brake spring (b) on the kick starter axle. Then continue to assemble the engine in the usual manner, as described in Section 5.1 on Page 23.

After the left-hand, side housing cover, or the fan cowling has been screwed on, locate the kick starter crank (check for starter rotation) and tighten with a hexagon head screw M 6 and a lock washer.

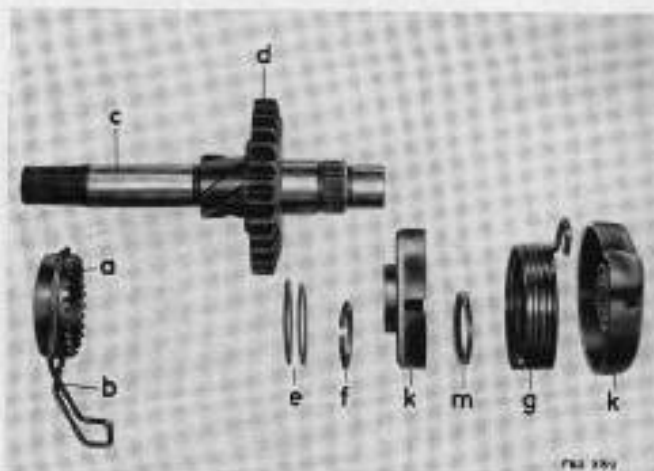

Fig. 55

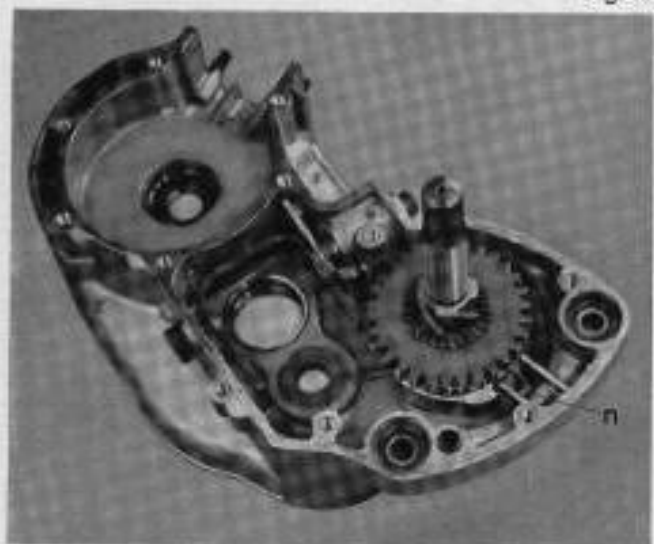

Fig. 56

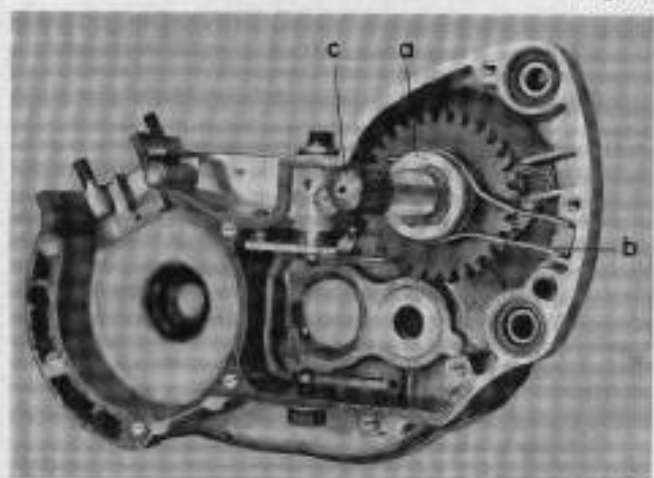

Fig. 57



